

Ring-Gabelschlüssel, lange Ausführung, gekröpft, für sicheres Arbeiten in der Höhe - 120/1-H

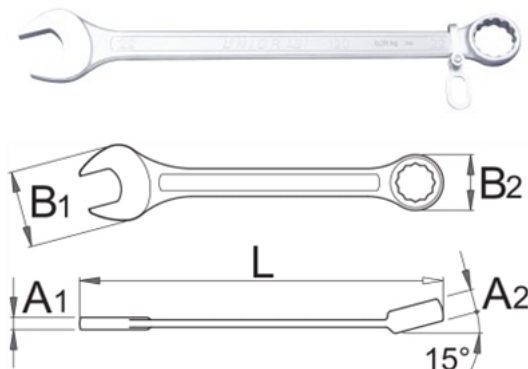

Beschreibung

- Material: Premium Chrom-Vanadium-Stahl
- geschmiedet, gehärtet und vergütet
- verchromt gemäß Industriestandard ISO 1456:2009
- polierter Kopf
- Ringseite mit dem Unior Schonprofil (gerundet)
- gefertigt laut Standard ISO 7738 (nur metrische Dim.)

Vorteile:

- nicht abnehmbarer, vernieteter Metallring
- Gewicht auf jedem Werkzeug vermerkt
- Ringe an den Werkzeugen ausreichend für zwei Karabiner, der einen sicheren Werkzeugwechsel bietet.
- Die Werkzeuge von Unior für Arbeiten in der Höhe sind so ausgelegt, dass die Grundfunktionen des Werkzeugs, seine Ergonomie und seine Zweckmäßigkeit erhalten bleiben.
- Der gleitende Metallring hat keine Beeinträchtigung für die Verwendung des Schlüssels an beiden Seiten





Technische Daten





Barcode	UNIOR	L	B2	B1	A2	A1	Weight	Carabiner	Ring	Other
62607 6	6	119	10,4	14,5	5	3,5	0,014	-	-	-
62607 7	7	129	11,5	16,5	5,8	3,9	0,015	1V	1	-
62607 8	8	141	13,2	18,5	6,9	3,9	0,023	1V	1	-
62607 9	9	152	14,	21	7,3	4	0,027	1V	1	-
62608 0	10	163	15,9	23	7,5	4,2	0,037	1V	1	-
62608 1	11	176	17,8	24,5	8	4,5	0,045	1V	1	-
62608 2	12	186	19,4	26,5	8,5	4,7	0,055	1V	1	-
62608 3	13	199	20,4	29,5	8,5	5,2	0,068	1V	1	-
62608 4	14	210	22	31,5	9	5,2	0,082	1V	1	-
62608 5	15	222	23,5	33,5	9,5	5,7	0,096	1V	1	-
62608 6	16	234	24,8	36	10,5	6,2	0,121	1V	1	-
62608 7	17	245	16,1	38	10,5	6,7	0,144	1V	1	-
62608 8	18	257	27,7	40	11	7,2	0,165	1V	1	-
62608 9	19	268	29,3	42	12	7,2	0,186	1V	1	-
62609 0	20	280	31	44	12,5	7,7	0,225	1V	1	-
62609 1	21	291	32,6	45,5	13	8,2	0,251	1V	1	-
62609 2	22	303	34,1	46,5	13	8,2	0,266	1V	1	-
62609 3	23	314	35,7	50,5	13	8,2	0,300	1V	1	-
62609 4	24	330	37,3	52,5	14	8,5	0,382	1V	1	-
62609 5	25	337	39	54,5	14,5	8,5	0,377	1V	1	-
62609 6	26	349	40,1	56	15	8,5	0,422	1V	1	-
62609 7	27	360	41,6	57,5	15	9	0,453	1V	1	-
62609 8	28	373	43,2	59,5	15,1	9	0,532	1V	1	-
62609 9	29	383	44,9	61,5	16	9,5	0,567	1V	1	-
62610 0	30	395	46,5	63,5	16	10	0,632	1V	1	-

		L	B2	B1	A2	A1				
62610 1	32	416	49	68	16,5	10,5	0,719	1V	1	-
62617 6	35	500	53,5	78,8	20	13,6	1,405	1V	1	-
62611 7	36	500	53,5	78,8	20	13,6	1,415	1V	1	-
62617 4	38	515	58	82,8	20,5	14,1	1,310	1V	1	-
62611 8	41	540	62	86,8	21	14,6	2,025	1V	1	-
62632 1	50	580	75	103	24	17	1,955	1V	1	-
62629 5	1/4"	119	10,4	14,5	5	3,5	0,014	1V	1	-
62629 6	5/16"	142	13,2	18,5	6,9	3,9	0,023	1V	1	-
62629 7	3/8"	153	14,3	21	7,3	4	0,027	1V	1	-
62629 8	7/16"	176	17,8	24,5	8	4,5	0,045	1V	1	-
62629 9	1/2"	199	20,4	29,5	8,5	5,2	0,068	1V	1	-
62630 0	9/16"	211	22	31,5	9	5,2	0,082	1V	1	-
62630 1	5/8"	234	24,8	36	10,5	6,2	0,121	1V	1	-
62630 2	11/16"	245	26,1	38	10,5	6,7	0,144	1V	1	-
62630 3	3/4"	268	29,3	42	12	7,2	0,186	1V	1	-
62630 4	13/16"	291	32,6	45,5	13	8,2	0,251	1V	1	-
62630 5	7/8"	303	34,1	46,5	13	8,2	0,266	1V	1	-
62630 6	15/16"	330	37,3	52,5	14	8,5	0,382	1V	1	-
62630 7	1"	337	39	54,4	14,5	8,5	0,377	1V	1	-
62630 8	1.1/16"	360	41,6	57,5	15	9	0,453	1V	1	-
62630 9	1.1/8"	372	43,2	59,5	15,5	9	0,532	1V	1	-
62631 0	1.1/4"	417	49	68	16,5	10,5	0,719	1V	1	-
62631 1	1.5/16"	417	49	68	16,5	10,5	0,732	1V	1	-
62631 2	1.3/8"	500	53,5	78,8	20	13,6	1,425	1V	1	-
62631 3	1.7/16"	500	53,5	78,8	20	13,6	1,395	1V	1	-
62631 4	1.1/2"	500	53,5	78,8	20	13,6	1,335	1V	1	-
62631 5	1.5/8"	540	62	86,8	21	14,6	1,975	1V	1	-
62631 6	1.11/16"	540	62	86,8	21	14,6	1,995	1V	1	-

Verpackungsangaben

	Größe inklusive SB-Verpackung			Transportverpackung		
	Einzelhandelsverpackung mm (Länge)	Einzelhandelsverpackung mm (Breite)	Einzelhandelsverpackung mm (Höhe)			
62607 6	-	-	-	-	-	-
62607 7	-	-	-	-	-	-
62607 8	-	-	-	-	-	-
62607 9	-	-	-	-	-	-

	Größe inklusive SB-Verpackung			Transportverpackung					
	Einzel hande lsverk aufsv erpac kung mm (Läng e)	Einzel hande lsverk aufsv erpac kung mm (Breit e)	Einzel hande lsverk aufsv erpac kung mm (Höhe)			Versa ndver packu ng in g (Gewi cht)	Versa ndver packu ng in g (Gewi cht)	Versa ndver packu ng in g (Gewi cht)	
626080	-	-	-	-	-	-	-	-	-
626081	-	-	-	-	-	-	-	-	-
626082	-	-	-	-	-	-	-	-	-
626083	-	-	-	-	-	-	-	-	-
626084	-	-	-	-	-	-	-	-	-
626085	-	-	-	-	-	-	-	-	-
626086	-	-	-	-	-	-	-	-	-
626087	-	-	-	-	-	-	-	-	-
626088	-	-	-	-	-	-	-	-	-
626089	-	-	-	-	-	-	-	-	-
626090	-	-	-	-	-	-	-	-	-
626091	-	-	-	-	-	-	-	-	-
626092	-	-	-	-	-	-	-	-	-
626093	-	-	-	-	-	-	-	-	-
626094	-	-	-	-	-	-	-	-	-
626095	-	-	-	-	-	-	-	-	-
626096	-	-	-	-	-	-	-	-	-
626097	-	-	-	-	-	-	-	-	-
626098	-	-	-	-	-	-	-	-	-
626099	-	-	-	-	-	-	-	-	-
626100	-	-	-	-	-	-	-	-	-
626101	-	-	-	-	-	-	-	-	-
626176	-	-	-	-	-	-	-	-	-
626177	-	-	-	-	-	-	-	-	-
626174	-	-	-	-	-	-	-	-	-
626118	-	-	-	-	-	-	-	-	-
626321	-	-	-	-	-	-	-	-	-
626295	-	-	-	-	-	-	-	-	-
626296	-	-	-	-	-	-	-	-	-
626297	-	-	-	-	-	-	-	-	-
626298	-	-	-	-	-	-	-	-	-
626299	-	-	-	-	-	-	-	-	-
626300	-	-	-	-	-	-	-	-	-
626301	-	-	-	-	-	-	-	-	-
626302	-	-	-	-	-	-	-	-	-

	Größe inklusive SB-Verpackung			Transportverpackung					
	Einzel hande lsverk aufsv erpac kung mm (Läng e)	Einzel hande lsverk aufsv erpac kung mm (Breit e)	Einzel hande lsverk aufsv erpac kung mm (Höhe)			Versa ndver packu ng in g (Gewi cht)	Versa ndver packu ng in g (Gewi cht)	Versa ndver packu ng in g (Gewi cht)	
626303	-	-	-	-	-	-	-	-	-
626304	-	-	-	-	-	-	-	-	-
626305	-	-	-	-	-	-	-	-	-
626306	-	-	-	-	-	-	-	-	-
626307	-	-	-	-	-	-	-	-	-
626308	-	-	-	-	-	-	-	-	-
626309	-	-	-	-	-	-	-	-	-
626310	-	-	-	-	-	-	-	-	-
626311	-	-	-	-	-	-	-	-	-
626312	-	-	-	-	-	-	-	-	-
626313	-	-	-	-	-	-	-	-	-
626314	-	-	-	-	-	-	-	-	-
626315	-	-	-	-	-	-	-	-	-
626316	-	-	-	-	-	-	-	-	-