

## WARRANTY

This warranty is given by Ensitech Pty Ltd of Unit 1, 144, Old Bathurst Road, Emu Plains NSW 2750, Australia, Tel: +61 2 4735 7700, Email: info@tigbrush.com. The benefits given by each warranty set out in this document are in addition to any other rights and remedies you may have under a law in relation to the services or goods to which the warranty relates. Our goods come with guarantees that cannot be excluded under the Australian Consumer Law. You are entitled to a replacement or refund for a major failure and for compensation for any other reasonably foreseeable loss or damage. You are also entitled to have the goods repaired or replaced if the goods fail to be of acceptable quality and the failure does not amount to a major failure. Unless otherwise stated you will bear the cost of claiming the warranty.

### What this warranty covers

This warranty applies to any defects in the goods that appears within 24 months from the date of delivery of the goods to you. To claim under this warranty, the defects must be notified to Ensitech and the goods returned to Ensitech within two weeks of their appearance. Ensitech will, at its option, replace or repair the goods within a reasonable time of receiving a valid warranty claim. Ensitech will pay for the repair or replacement but you must pay all other costs including all transport costs of returning the defective goods to Ensitech and Ensitech delivering the repaired or replacement part back to you.

### How to make a claim

If you want to make a claim under your warranty, please contact Ensitech Pty Ltd in writing by sending a pre-paid letter to Ensitech Pty Ltd, PO Box 179, Springwood NSW 2777, Australia, or email to info@tigbrush.com. You must include your full name, address and contact telephone number and the details of the defect in relation to which you make your claim. Ensitech will tell you whether you need to return the goods to Ensitech Pty Ltd or the approved local distributor. You will need to return the goods together with all accessories and parts for a full assessment and report.

### Additional limitations, exclusions and requirements

This warranty does not extend to:

- consumables such as the brush, insulating shroud and wand;
- any defect caused by normal wear and tear or incidental or inconsequential damage;
- any defect caused by misuse, negligence or other abuse of the goods;
- any defect caused by accidents or alterations;
- goods that have not been cleaned and maintained in accordance with the user's manual supplied with the goods;
- loss or damage, including consequential loss or damage, to your work or facilities arising out of or in connection with the use of the TIG Brush; or
- unless otherwise expressly stated, any right to be reimbursed or compensated for physical or financial injury, loss, damage, expense, time or inconvenience (whether direct or indirect) arising out of the occurrence of the defect in the product or your inability to use the product.

**Model:** TBE-250      **Serial No.** 9002812

**Date of Purchase:**

**Purchased from:**



TIG Brush TBE-250 Instruction Manual Oct 2013 (USA)

Ensitech Pty Ltd Unit 1/144 Old Bathurst Road, Emu Plains NSW 2750, Australia  
Phone: +61 2 4735 7700 Email: info@tigbrush.com

329595/0016  
Reinigungsgerät TIG Brush TBE-250 Set



(ST) S/N:

# TIG Brush® TBE-250

## Stainless Steel Weld Cleaning System

# Operation, Safety and Maintenance Manual



Ensitech Pty Ltd  
www.tigbrush.com

TBE-250 Instruction Manual  
Oct 2013 (USA)

### FOREWORD

This manual is a very important tool! Keep it with the machine at all times.

The purpose of this manual is to provide users with the necessary operating procedures and precautions, essential for the safe and proper operation of the TIG Brush.

Due to continuous improvements, Ensitech Pty Ltd reserves the right to make specification changes.

© 2011 Ensitech Pty Ltd

### 8.3 ON/OFF SWITCH & FRONT PANEL POWER LIGHT ILLUMINATED & UNIT NOT OPERATING

- Ensure the TIG Brush circuit breaker is reset (it should be pressed in – see back of unit).
- Ensure the Power Control is not set to STANDBY.
- Ensure the cables are securely plugged into the front of the TIG Brush.
- Ensure the clamp is gripping the work securely. Sometimes the clamp position may need adjusting to make a good contact. If dirt or debris has built up on the clamp, clean it as this may prevent a good contact being made.
- Ensure the brush is wet with fluid.
- Ensure that the work is conductive. If the metal has a plastic film or a thick layer of oxide, the current cannot flow through the work. A mechanical or chemical method may need to be used to remove any insulating film before the TIG Brush can be used.
- Examine all cables for damage and ensure all the cables are properly connected.
- Ensure the brush is securely screwed into the wand.  
NOTE: Be careful when checking, as a loose connection may be extremely hot.
- Check screw threads on the handle, wand and brush for dirt and contamination in the screw threads and clean if required.



Contact your TIG Brush distributor or visit the website for more help [www.tigbrush.com](http://www.tigbrush.com)

## S8 TROUBLESHOOTING

If the TIG Brush is not operating correctly, please refer to the following trouble shooting guide before contacting your TIG Brush distributor.

### 8.1 ON/OFF SWITCH NOT ILLUMINATED

- Ensure the power switch is ON (with the “I” symbol on the switch pressed in).
- Ensure the power cable is pushed completely into the socket on the side of the TIG Brush.
- Ensure power is present at the power point (possibly by plugging in another appliance, such as an inspection light).
- Check the fuse located below the mains socket. Using a small screwdriver, place the tip in the indentation under the plastic fuse drawer and pull out the drawer. If the fuse at the end of the drawer is broken replace with a fuse of the same specification (8 amp, slow blow fuse, size M205).
- If the fuse blows again, contact your TIG Brush Supplier.

### 8.2 ON/OFF SWITCH ILLUMINATED & FRONT PANEL POWER LIGHT NOT ILLUMINATED

- If the TIG Brush was being used prior to it turning off, and the heat-sink at the back of the unit feels hot (be careful as it may be very hot) the unit may have over-heated. Wait 30 minutes for the unit to cool down before trying to use it again. The unit can be cooled more quickly by placing a damp cloth on the heat-sink.

## FOREWORD

### SAFETY ALERT SYMBOLS AND SAFETY SIGNAL WORDS



## WARNING

THIS IS THE SAFETY ALERT SYMBOL. IT IS USED TO ALERT YOU TO THE POTENTIAL PERSONAL INJURY HAZARDS. OBEY ALL SAFETY MESSAGES THAT FOLLOW THIS SYMBOL TO AVOID POSSIBLE INJURY.



## DANGER

INDICATES AN IMMEDIATELY HAZARDOUS SITUATION. IF NOT AVOIDED, MAY RESULT IN MINOR OR MODERATE INJURY. IT MAY ALSO ALERT AGAINST UNSAFE PRACTICES.



## CAUTION

INDICATES AN IMMEDIATELY HAZARDOUS SITUATION. IF NOT AVOIDED, MAY RESULT IN MINOR OR MODERATE INJURY. IT MAY ALSO ALERT AGAINST UNSAFE PRACTICES.



THIS SYMBOL INDICATES AN IMMEDIATELY HAZARDOUS SITUATION WHICH SHOWS ENSITECH'S PROVISIONS FOR THE MILD ACID. IF PRECAUTIONS ARE NOT TAKEN, MAY RESULT IN MINOR OR MODERATE INJURY.



SYMBOL FOR “VOID WARRANTY” OR “DAMAGED WORK”

## FOREWORD

### FOR:

- Accident reporting
- Product safety publications
- Current owner updates
- Questions regarding product safety
- Standards and regulations compliance information
- Questions regarding special product applications
- Questions regarding product modifications

### CONTACT

Your local TIG Brush distributor.  
[www.tigbrush.com](http://www.tigbrush.com)

  
ensitech™  
Ensitech Pty Ltd  
Unit 1/144 Old Bathurst Road  
Emu Plains NSW 2750  
Australia

Phone: +61 2 4735 7700  
Email: [info@tigbrush.com](mailto:info@tigbrush.com)

## S7 CONSUMABLES

Consumable supplies are available from authorized TIG Brush distributors.

### 7.1 BRUSHES

The brush will wear down with use and need replacing before the bristles reach the insulating shroud.

### 7.2 INSULATING SHROUD

The insulating shroud may become damaged or heat-affected. Replacement shrouds are available.

### 7.3 CLEANING FLUIDS

A range of cleaning fluids is available including:

- TB-21ND Weld Cleaning Fluid: for cleaning & polishing.
- TB-25 Weld Cleaning Fluid: for cleaning & polishing.
- TB-30ND Weld Cleaning Fluid: biodegradable for cleaning only.
- TB-31ND Neutral Weld Cleaning Fluid: neutral pH, for cleaning only.

### 7.4 NEUTRALIZING FLUID

Neutralizing fluids which ensure removal of all cleaning fluid residue are available including:

- TB-40 Neutralizing Fluid for TB-21ND and TB-25.
- TB-41 Neutralizing Fluid for TB-30ND.

### 7.5 MARKING FLUIDS

- TB-90 Marking Fluid: can be used with custom stencils to indelibly mark metals.

### 7.6 OTHER FLUIDS

- A range of Pre-Weld Cleaning, Cleaning and Finishing fluids is available for stainless steel and other metals, to remove surface contamination and provide a clean mark-free finish.

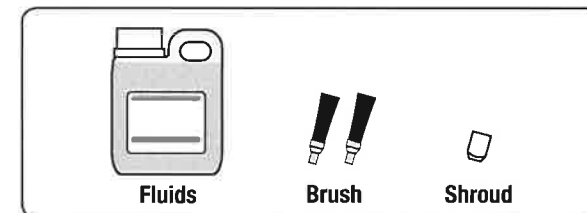

## S6 MAINTENANCE

### 6.1 MAINTENANCE

- When not in use, ensure the On/Off switch is OFF. The green power light on the front panel and the On/Off switch should not be illuminated.
- Rinse brush with water to remove excess cleaning fluid.
- At completion of a work shift, unscrew brush from wand. Remove the brush from the insulating shroud and rinse brush, shroud and end of wand with water to remove cleaning solution. Allow to dry before re-assembling.
- Before assembling the brush to the wand, coat threads with copper filled anti-seize compound. This will exclude the acidic solution from the joints and prevent corrosion.
- Rinse clamp with water to remove solution and prevent corrosion.
- Use a wet cloth to wipe fluid splashes off the TIG Brush control unit. After some time splashes and marks may accumulate and become difficult to remove.

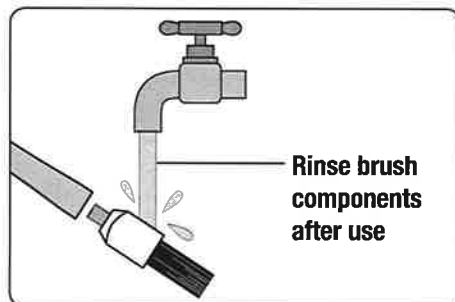
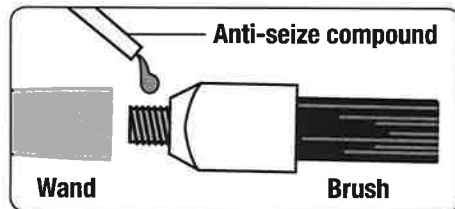

## REVISIONS LOG

### REVISIONS LOG

Original Issue of Manual: May 2010

Revision: February 2012

Revision: October 2013

## CONTENTS

<b>S1</b>	<b>INTRODUCTION</b>	<b>7</b>
<b>S2</b>	<b>SAFETY PRECAUTIONS</b>	<b>8</b>
<b>S3</b>	<b>DESCRIPTION OF APPARATUS</b>	<b>10</b>
<b>S4</b>	<b>OPERATION</b>	<b>12</b>
	4.1 Preparation	12
	4.2 Assembly	12
	4.3 Cleaning Fluid	12
	4.4 Operation	14
<b>S5</b>	<b>POWER AND GRADE SETTING</b>	<b>15</b>
	5.1 Power Settings	15
	5.2 Mode Settings	15
<b>S6</b>	<b>MAINTENANCE</b>	<b>16</b>
<b>S7</b>	<b>CONSUMABLES</b>	<b>17</b>
	7.1 Brushes	17
	7.2 Insulating Shroud	17
	7.3 Cleaning Fluid	17
	7.4 Neutralizing Fluid	17
	7.5 Marking Fluid	17
	7.6 Other Fluids	17
<b>S8</b>	<b>TROUBLESHOOTING</b>	<b>18</b>
	8.1 On/Off Switch Not Illuminated	18
	8.2 On/Off Switch Illuminated & Front Panel Power Light Not Illuminated	18
	8.3 On/Off Switch & Front Panel Power Light Illuminated & Unit Not Operating	19

## S5 POWER AND GRADE SETTINGS

### 5.1 POWER SETTINGS

Choose the cleaning intensity required by selecting the appropriate setting using the Power Control.



**STANDBY** - Power is not transmitted to the brush.



**LOW** - Use for light work and thin metals.



**HIGH** - Use for most cleaning operations. Provides fastest cleaning speed.

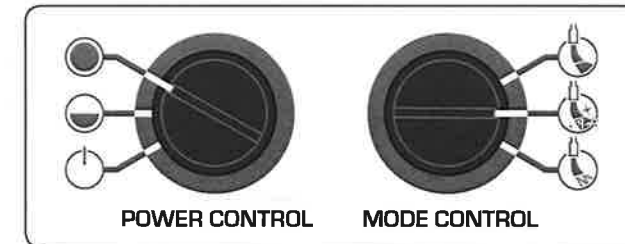

### 5.2 MODE SETTINGS

Choose the type of cleaning required by selecting the appropriate setting using the mode control.



**CLEAN** - This mode provides the fastest cleaning at each power setting. However, prolonged use may cause a milky appearance on the surface of the metal. If this happens, use RESTORE to rectify.



**RESTORE** - This mode provides metal polishing. Use this grade to repair a dull white surface, including one caused by over-use of CLEAN.







**MARKING** - This mode provides surface marking, when used with the appropriate chemical.

## S4 OPERATION

### 4.4 OPERATION

Refer to illustrations on pages 13 and 15.

1. Set POWER control to STANDBY. Always use this setting when connecting the clamp or changing the tip.
-  2. Ensure the power cord is connected to a suitable 110V AC power outlet and connected to the TIG Brush power socket.
3. Turn the On/Off switch to ON. The On/Off switch should immediately be illuminated. If this does not occur, refer to the "Troubleshooting" section.
-  4. Make sure the brush tip has its insulating shroud and the insulation on the wand is undamaged.
5. Ensure the TIG Brush is switched on and all equipment is correctly connected as described above in section 4.2.
6. Select power level and operating mode using the rotary switches. See section 5 below for details.
7. Dip brush in cleaning fluid and apply brush tip to weld area to be cleaned. Use only recommended cleaning fluids, see S7.2.
8. Ensure brush and work area remain wet with the fluid during cleaning.
9. Apply brush only for as long as necessary to remove discoloration. Prolonged application may affect surface quality.
10. Some light sparking may occur where brush tip contacts workpiece, particularly on higher power settings, and this is normal. Excessive sparking for a prolonged time in one area may cause surface pitting.
11. When desired surface finish is achieved, turn the TIG Brush Power Control to OFF.
-  12. After use put the brush down on a non-flammable surface as it may be very hot.
-  13. Be careful touching the work as it may be hot.
14. Rinse thoroughly with clean water to remove all traces of cleaning fluid. To ensure acidic residue is removed, use the recommended Ensitech neutralizing fluid, see S7.3.

## S1 INTRODUCTION

### INTRODUCTION

The TIG Brush is a metal cleaner/polisher. It uses the action of an electric current along with a fluid to remove heat marks and other surface imperfections from metal surfaces. This model has been specifically designed to clean heat marks left by TIG welding stainless steel.

Several cleaning solutions are available, each suited to different applications. Contact Ensitech for more information, or visit our website [www.tigbrush.com](http://www.tigbrush.com)

## S2 SAFETY PRECAUTIONS

### SAFETY PRECAUTIONS

Protect yourself and others by observing all safety information, warnings and cautions. Failure to comply with instructions could result in personal injury and/or damage to the product or property.

Read this documentation carefully before operating the equipment. Please retain these instructions for future reference.

Before using the TIG Brush, make sure the work environment is well ventilated and away from any combustible substances. Ensure that all required equipment is available.



### WARNING

Do not use the TIG Brush for any purpose other than that described in this manual. Failure to observe this warning may result in permanent damage to the TIG Brush, cause damage to the workpiece, cause injury to the operator and void the warranty.

### SAFETY INFORMATION

The TIG Brush is one of the safest appliance in its class. However some precautions must be taken with the use of the TIG Brush, as with any electro-cleaner.

- The TIG Brush uses mild acids; gloves should be used to avoid prolonged contact with any of the fluids.
- Goggles should be worn to prevent fluid being splashed in the eyes.

## S4 OPERATION

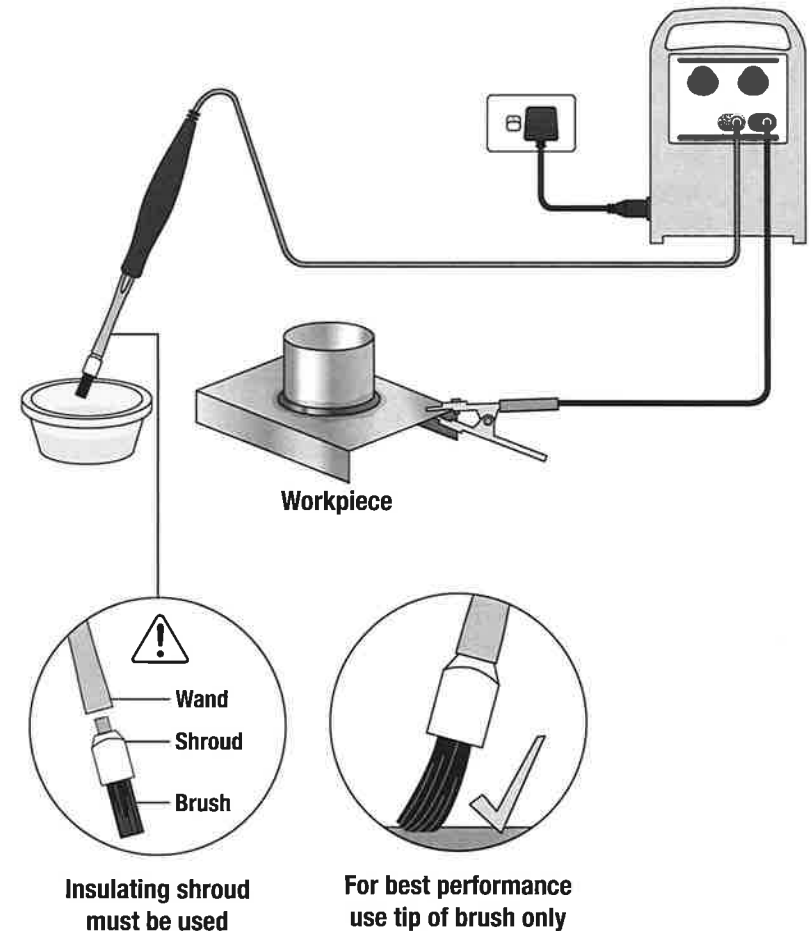



## S4 OPERATION

### 4.1 PREPARATION

1. Inspect unit and all cables for damage before use.
2. Ensure the unit is dry.
3. Ensure the work environment is well ventilated and away from any combustible substances.
4. Ensure that cables do not present a trip hazard.
5. If the items to be cleaned are small, place the parts in a plastic container that can hold acidic fluids safely.
6. Parts will need to be sprayed with the recommended Ensitech neutralizer or washed down with water after cleaning. Ensure there is ready access to water and a suitable place for washing.
7.  Wear suitable personal protective equipment as recommended in the MSDS. The minimum requirement is for gloves to protect hands from the fluid, and goggles to prevent fluid splashing into the eyes.

### 4.2 ASSEMBLY

Refer to illustration on page 10.

1. Attach connector of red cable to red connector of TIG Brush Unit.
2. Screw wand into handle.
3. Place shroud on brush and screw into wand.
4. Attach connector of black cable to black connector of TIG Brush Unit.
5. Set POWER switch to "OFF".
6. Attach power cord to mains outlet and TIG Brush Unit.
7. Attach clamp to workpiece.

### 4.3 CLEANING FLUID

Pour a small quantity of the Cleaning Fluid into a shallow bowl. Place the container close to the work because the tip will be dipped into the fluid regularly during operation.

## S2 SAFETY PRECAUTIONS

- Fluid spilled on the skin should be washed off as soon as practical.
- Material Safety Data Sheet is available for all chemicals and should be read before use.
- The brush gets extremely hot, around 392°F degrees Fahrenheit. Be very careful touching the brush. Do not place the brush near any flammable materials.
- The TIG Brush produces an electric current which may generate small sparks between the brush and the metal being cleaned.
- Hydrogen gas may also be generated (which is an invisible but explosive gas). Always use the apparatus in a well ventilated area. Do not use near flammable substances, or in areas where dense flammable gases (such as petrol vapor) may accumulate.
- The TIG Brush TBE-250 uses 110V AC only. Do not use with any other voltage. If the power cord is damaged or if the TIG Brush has been dropped from a height and damaged, do not use the unit. Contact your TIG Brush supplier to have the TIG Brush inspected and repaired.
- Do not short out the terminals, or use the TIG Brush with a damaged wand or cables. Doing so may permanently damage the TIG Brush and cause damage to the workpiece being cleaned. The high currents involved may also cause intense heating of the shorted or damaged part, which could result in burns to the operator.
- Ensure that the TIG Brush is located where it cannot easily fall and cause injury. Ensure that the cables do not present a trip hazard.



### S3 DESCRIPTION OF APPARATUS

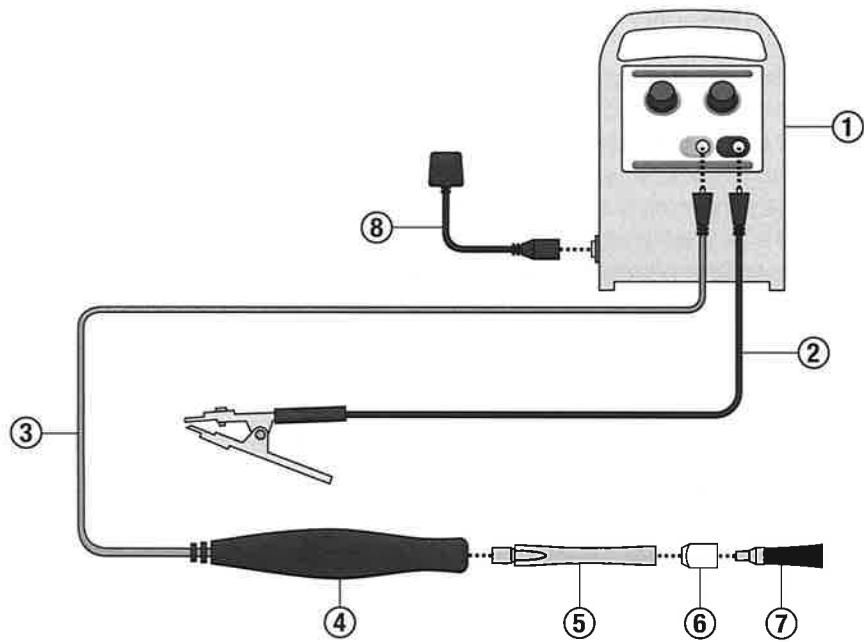

- ① TIG Brush Control Unit
- ② Clamp Cable
- ③ Handle Cable
- ④ Handle
- ⑤ Wand
- ⑥ Shroud
- ⑦ Brush
- ⑧ Power Cord

### S3 DESCRIPTION OF APPARATUS

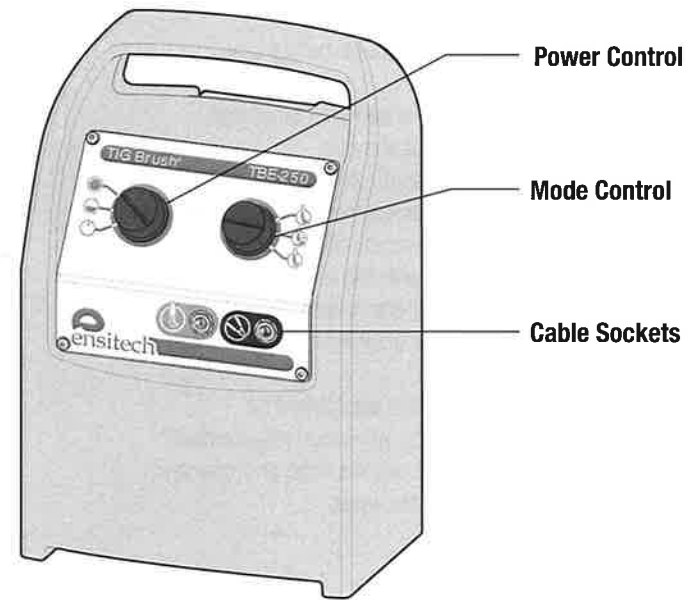

Power Control

Mode Control

Cable Sockets

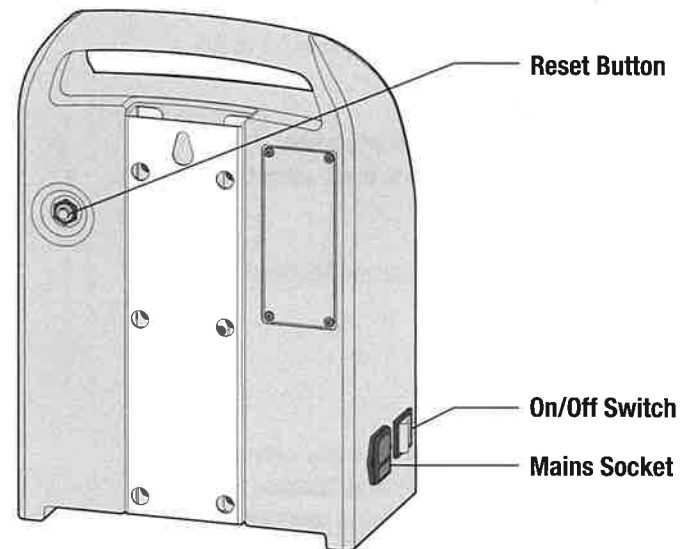

Reset Button

On/Off Switch

Mains Socket