

W2000X, Spannrad- & Reduziereinsätze, zöllig **ENERPAC**

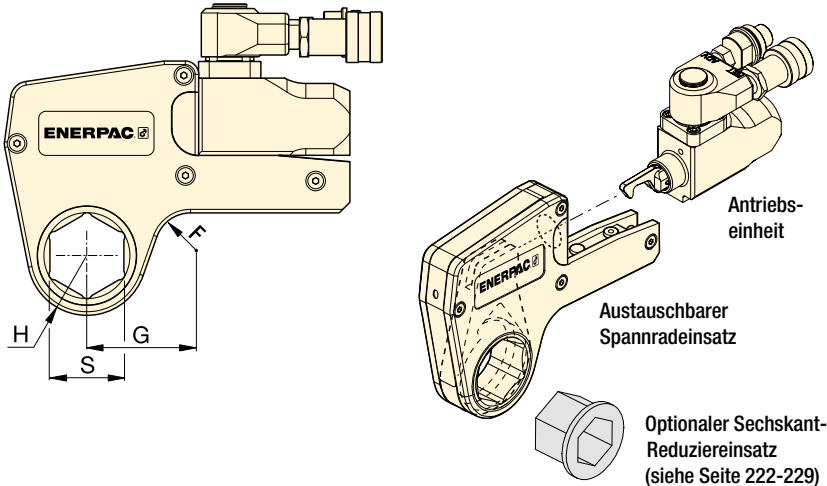

W
Serie
X-Edition



Nenn Drehmoment bei 690 bar:
2766 Nm

Sechskantbereich:
1¹/₁₆ - 2³/₈ Zoll

Max. Betriebsdruck:
690 bar









Metrische Größen
Für die metrischen Größen von Spannrad- und Reduziereinsätzen siehe:
Seite: 228



Größen von Sechskant-Bolzen und Muttern
Siehe die Tabelle mit den Größen von Sechskant-Bolzen, Muttern und den betreffenden Schraubenmaßen.
Seite: 407

▼ AUSWAHLTABELLE

Antriebs-einheit	Sechskant-größe ¹⁾	Kopf-radius	Abm.	Modell-Nummer							
						Sechskant-Reduzier-einsatz (Zoll)	Modell-Nummer	Sechskant-Reduzier-einsatz (Zoll)	Modell-Nummer	Sechskant-Reduzier-einsatz (Zoll)	Modell-Nummer
	S (Zoll)	H (mm)	G (mm)		(kg)						
W2000X	1 ¹ / ₁₆	31,0	53,7	W2101X	2,1	-	-	-	-	-	-
	1 ¹ / ₈	31,0	53,7	W2102X	2,1	-	-	-	-	-	-
	1 ³ / ₁₆	31,0	53,7	W2103X	2,1	-	-	-	-	-	-
	1 ¹ / ₄	31,0	53,7	W2104X	2,1	-	-	-	-	-	-
	1 ⁵ / ₁₆	31,0	53,7	W2105X	2,1	-	-	-	-	-	-
	1 ³ / ₈	31,0	53,7	W2106X	2,1	-	-	-	-	-	-
	1⁷/₁₆	31,0	53,7	W2107X	2,1	1⁷/₁₆ - 1¹/₈	W2107R102	-	-	-	-
	1 ¹ / ₂	33,5	58,2	W2108X	2,2	-	-	-	-	-	-
	1 ⁹ / ₁₆	33,5	58,2	W2109X	2,2	-	-	-	-	-	-
	1 ⁵ / ₈	33,5	58,2	W2110X	2,2	1 ⁵ / ₈ - 1 ¹ / ₄	W2110R104	1 ⁵ / ₈ - 1 ³ / ₁₆	W2110R103	-	-
	1 ¹¹ / ₁₆	36,5	60,5	W2111X	2,2	-	-	-	-	-	-
	1 ³ / ₄	36,5	60,5	W2112X	2,2	-	-	-	-	-	-
	1 ¹³ / ₁₆	36,5	60,5	W2113X	2,2	1 ¹³ / ₁₆ - 1 ⁷ / ₁₆	W2113R107	1 ¹³ / ₁₆ - 1 ¹ / ₄	W2113R104	-	-
	1 ⁷ / ₈	39,0	63,1	W2114X	2,2	-	-	-	-	-	-
	1 ¹⁵ / ₁₆	39,0	63,1	W2115X	2,2	-	-	-	-	-	-
	2	39,0	63,1	W2200X	2,2	2 - 1⁵/₈	W2200R110	2 - 1⁷/₁₆	W2200R107	-	-
	2 ¹ / ₁₆	41,8	68,6	W2201X	2,3	-	-	-	-	-	-
	2 ¹ / ₈	41,8	68,6	W2202X	2,3	-	-	-	-	-	-
	2 ³ / ₁₆	41,8	68,6	W2203X	2,3	2 ³ / ₁₆ - 1 ¹³ / ₁₆	W2203R113	2 ³ / ₁₆ - 1 ⁵ / ₈	W2203R110	2 ³ / ₁₆ - 1 ⁷ / ₁₆	W2203R107
	2 ¹ / ₄	44,5	64,8	W2204X	2,2	-	-	-	-	-	-
2 ⁵ / ₁₆	44,5	64,8	W2205X	2,2	-	-	-	-	-	-	
2 ³ / ₈	44,5	64,8	W2206X	2,2	2 ³ / ₈ - 2	W2206R200	2 ³ / ₈ - 1 ⁷ / ₈	W2206R114	2 ³ / ₈ - 1 ¹³ / ₁₆	W2206R113	
-	-	-	-	-	-	2 ³ / ₈ - 1 ¹ / ₂	W2206R108	2 ³ / ₈ - 1 ⁷ / ₁₆	W2206R107	2 ³ / ₈ - 1 ⁵ / ₁₆	W2206R110

¹⁾ Siehe die Tabelle auf Seite 407 für eine Übersicht über die Größen von Sechskant-Bolzen, Muttern und die betreffenden Schraubenmaße.